



A Brand New Story To Tell.

Brochure

Toox

RADOMONTE



RADOMONTE

- VENEZIA -



A Brand New Story To Tell.

Radomonte è un luxury brand italiano che firma rubinetteria di design, accessori e prodotti per il Wellness in acciaio inox.

Una visione che ha origine dalla trentennale esperienza nella produzione di rubinetteria di GEDA, casa madre del marchio, per dare forma a collezioni di prodotti di alta qualità che uniscono una artigianalità contemporanea a soluzioni tecnicamente innovative e rispettose dell'ambiente.

Il risultato, prodotti di design attenti ai più minuziosi dettagli, dove convivono una creatività ricercata e un fascino senza tempo.

Radomonte is an Italian luxury brand of designer mixers, accessories and products for Wellness made of stainless steel.

A vision that originates from the thirty years of experience in the production of mixers by GEDA, the parent company of the brand, to give shape to collections of high quality products that combine contemporary craftsmanship with technically innovative and environmentally friendly solutions.

The result are design products that have been studied up to the smallest detail, where refined creativity and timeless charm coexist.

Funzionalità. Design. Innovazione.

Le collezioni Radomonte nascono dall'esperienza e creatività di Stefano Macchion designer e fondatore del brand, che a partire da una raggiunta maturità di competenze dell'azienda nella produzione attraverso l'uso esclusivo dell'acciaio, ha voluto dare vita a un progetto che celebrasse la migliore qualità artigianale Made in Italy nel settore della rubinetteria di design.

Functionality. Design. Innovation.

Radomonte collections are born from the experience and creativity of Stefano Macchion - designer and founder of the brand - who, starting from the maturity of the company's skills in the production through the exclusive use of steel, wanted to give life to a project that celebrated the best of Made in Italy craftsmanship in the design tapware sector.

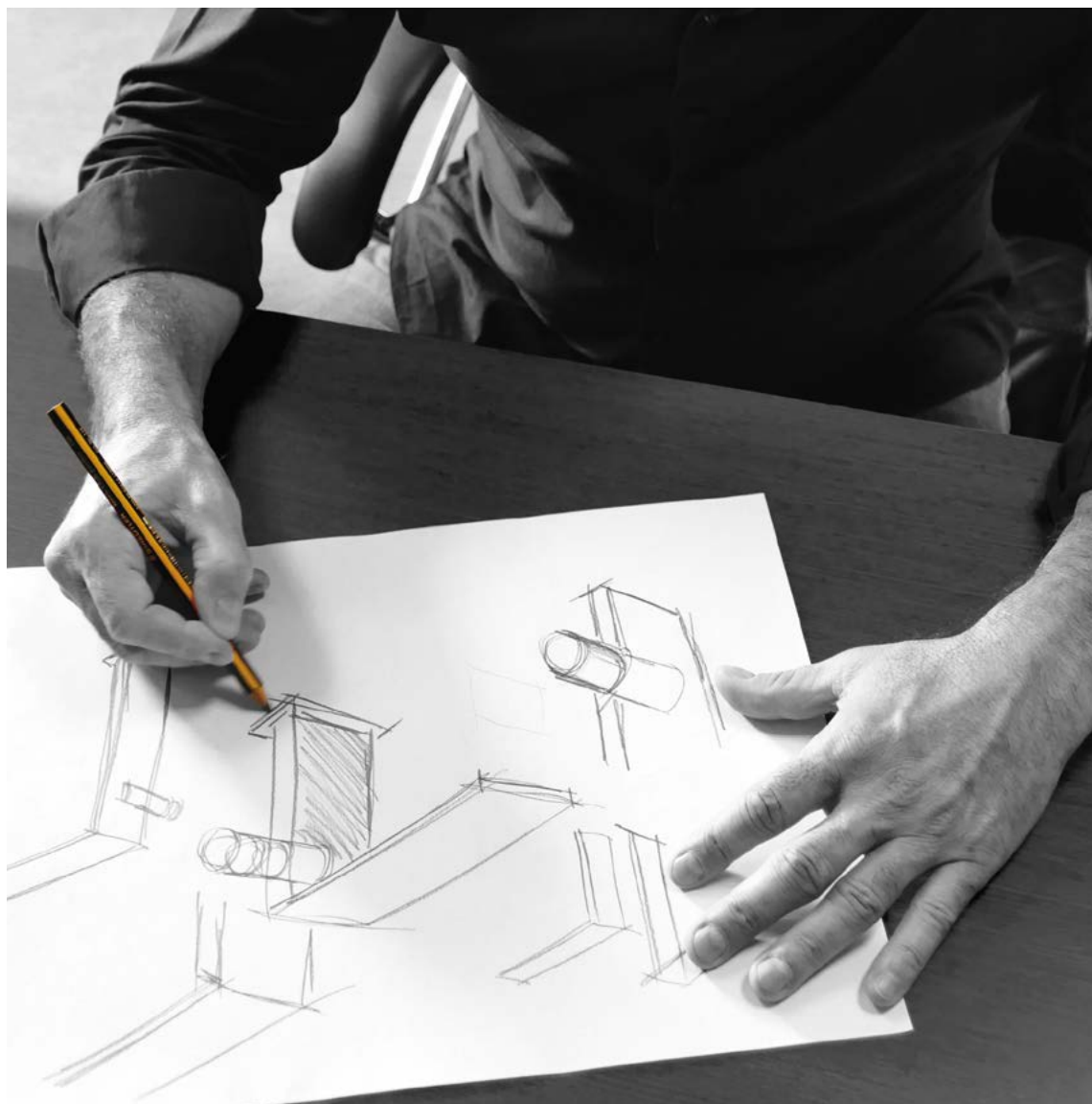

Design Is More

La ricerca creativa diventa un estremo atto di libertà. Il design dei prodotti Radomonte nasce da uno studio consapevole e attento dello stile che diventa poi atto di ribellione. Stravolgere le geometrie per giungere all'essenza della forma.

Ogni prodotto diventa la celebrazione di una storia e riesce a rendere la quotidianità una esperienza straordinaria.

Creative research becomes an extreme act of freedom. The design of Radomonte products comes from a conscious and careful study of style, which then becomes an act of rebellion. We twist the geometries to reach the essence of the shape.

Each product becomes the celebration of a story and manages to transform everyday life an extraordinary experience.



Solid With Charme

Tra le tendenze di design su cui si è concentrato negli ultimi anni il brand Radomonte c'è lo stile industriale, da cui hanno preso vita le collezioni Kàto e Kira.

Lo stile industriale nasce a metà degli anni Cinquanta quando gli architetti newyorkesi iniziarono a recuperare i magazzini e gli edifici industriali dismessi trasformandoli in abitazioni o atelier per artisti, come la celebre Factory di Andy Warhol.

La peculiarità di questi ambienti erano ampie superfici open space, in cui veniva mantenuta la struttura originale fatta di colonne, superfici materiche e tubature a vista.

Dallo stile industriale applicato al mondo del lusso nasce la corrente industrial chic, in cui l'iconica simbologia industriale si fonde con uno stile ricercato ed elegante. Il risultato sono ambienti in cui il rigore industrial si fa più morbido, dando vita ad atmosfere sofisticate e accoglienti. Per le personalità più eclettiche ed esigenti.



Among the design trends that Radomonte has focused on in recent years is the industrial style, from which the Kàto and Kira collections been created.

The industrial style was born in the mid-fifties when New York architects began to restore abandoned warehouses and industrial buildings, transforming them into homes or ateliers for artists, such as the famous Factory of Andy Warhol.

The peculiarity of these environments were large open spaces, in which the original structure made of columns, textured surfaces and exposed pipes was maintained.

The industrial chic trend is born from industrial style applied to the world of luxury, in which the iconic industrial symbolism blends with a refined and elegant style. The result can be seen in environments in which industrial rigor becomes softer, giving life to sophisticated and welcoming atmospheres. For the most eclectic and demanding personalities.



Hands Forging Beauty

Tutti i prodotti Radomonte sono realizzati esclusivamente in acciaio inox. Un materiale inerte, capace quindi di mantenersi inalterato nel tempo. La sua estrema resistenza superficiale lo protegge infatti dall'azione corrosiva di ruggine ed agenti esterni, garantendogli una durata eterna.

L'acciaio è una lega di ferro e carbonio che Radomonte usa nella variante AISI 316L, una variante dell'acciaio inox che, per il basso contenuto di carbonio, si caratterizza per essere ancora più resistente all'azione di sali e cloruri.

Radomonte products are made exclusively in stainless steel. An inert material, therefore able to remain unchanged over time. In fact, its extreme surface resistance protects it from the corrosive action of rust and external agents, guaranteeing an eternal duration.

Steel is an alloy of iron and carbon that Radomonte uses in the AISI 316L variant, a version of stainless steel which, due to its low carbon content, is characterized by being even more resistant to the action of salts and chlorides.

Le maniglie in vetro Radomonte sono realizzate in Vetro di Murano, secondo i metodi di lavorazione tradizionale dell'arte vetraria veneziana.

Ogni pezzo è realizzato artigianalmente e quindi unico.

Abbiamo scelto il vetro per le sue qualità ecologiche. Il vetro è atossico, perché composto solo da sostanze naturali. È resistente, igienico e riciclabile al 100%.

Per il suo riciclo, inoltre, necessita di temperature di fusione più basse con un conseguente risparmio energetico nella lavorazione.

Radomonte glass handles are made of Murano glass, according to the traditional processing methods of Venetian glass art.

Each piece is handcrafted and therefore unique.

We chose glass for its ecological qualities. Glass is non-toxic, because it is composed only of natural substances. It is resistant, hygienic and 100% recyclable.

Furthermore, for its recycling, it requires lower melting temperatures with consequent energy saving in processing.

Clearness And Tradition

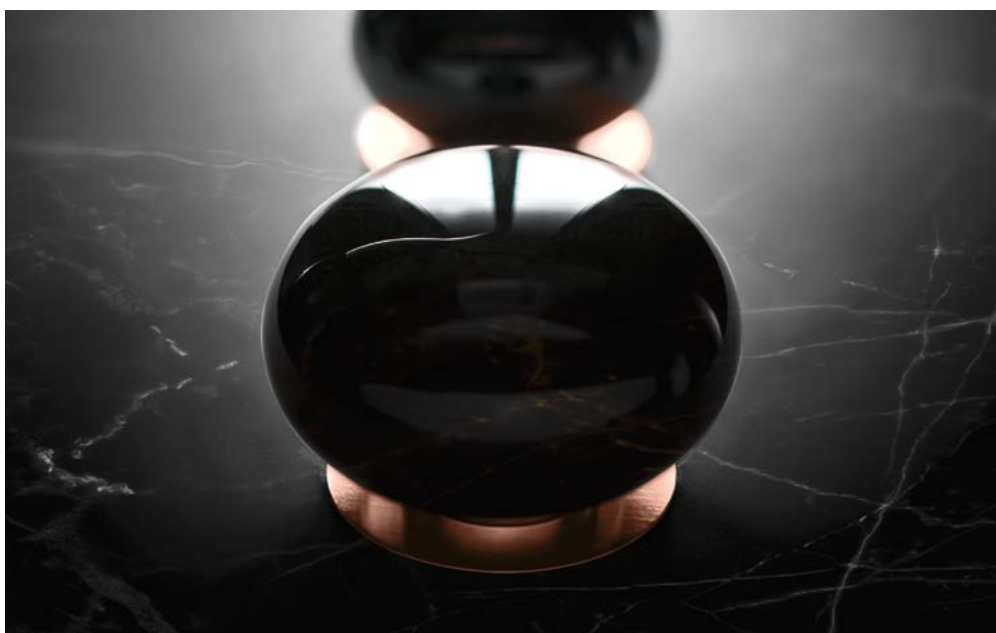



Put On Some MakeUp

Le collezioni Radomonte sono realizzate in acciaio inox in finitura spazzolata o lucida.

L'acciaio spazzolato è disponibile anche in finitura PVD oro, bronzo, roseè e carbon. Il PVD (Physical Vapor Deposition) è un trattamento di qualità superiore che crea un sottilissimo film sulla superficie del prodotto, aumentandone la resistenza superficiale. Il trattamento PVD è una lavorazione biocompatibile, che non crea danni all'ambiente o alla salute delle persone.

Le maniglie in vetro di Murano della collezione Dorin sono disponibili nei colori ghiaccio o ambra.

Radomonte collections are made of stainless steel in brushed or polished finish.

Brushed steel is also available in gold, bronze, roseè and carbon PVD finishes. PVD (Physical Vapor Deposition) is a superior quality treatment that creates a very thin film on the surface of the product, increasing its resistance. PVD treatment is a biocompatible process, which does not cause damage to environment or to people's health.

The Murano glass handles of the Dorin collection are available in ice or amber colors.

Radomonte si impegna per una produzione nel rispetto dell'ambiente, sia nelle lavorazioni aziendali, garantite da un sistema di qualità e ambientale certificato, che a beneficio del cliente finale.

Nella progettazione dei prodotti Radomonte, oltre all'utilizzo di materiali ecologici e riciclabili come l'acciaio inox e il vetro, una attenzione particolare è data alle soluzioni per il risparmio energetico e il consumo intelligente.

Da questo è nato il marchio Eco Energy System, creato dall'azienda per certificare lo sviluppo e la realizzazione di progetti attraverso tecnologie e materiali mirati al rispetto e alla salvaguardia dell'ambiente.

Radomonte is committed to an environmentally friendly production, both in company processes, guaranteed by a certified quality and environmental system, and for the benefit of the end customer.

In the design of Radomonte products, in addition to the use of ecological and recyclable materials such as stainless steel and glass, particular attention is given to solutions for energy saving and intelligent consumption.

From this policy the Eco Energy System brand was born, created by the company to certify the development and implementation of projects through technologies and materials aimed at respecting and protecting the environment.

We Care About Tomorrow

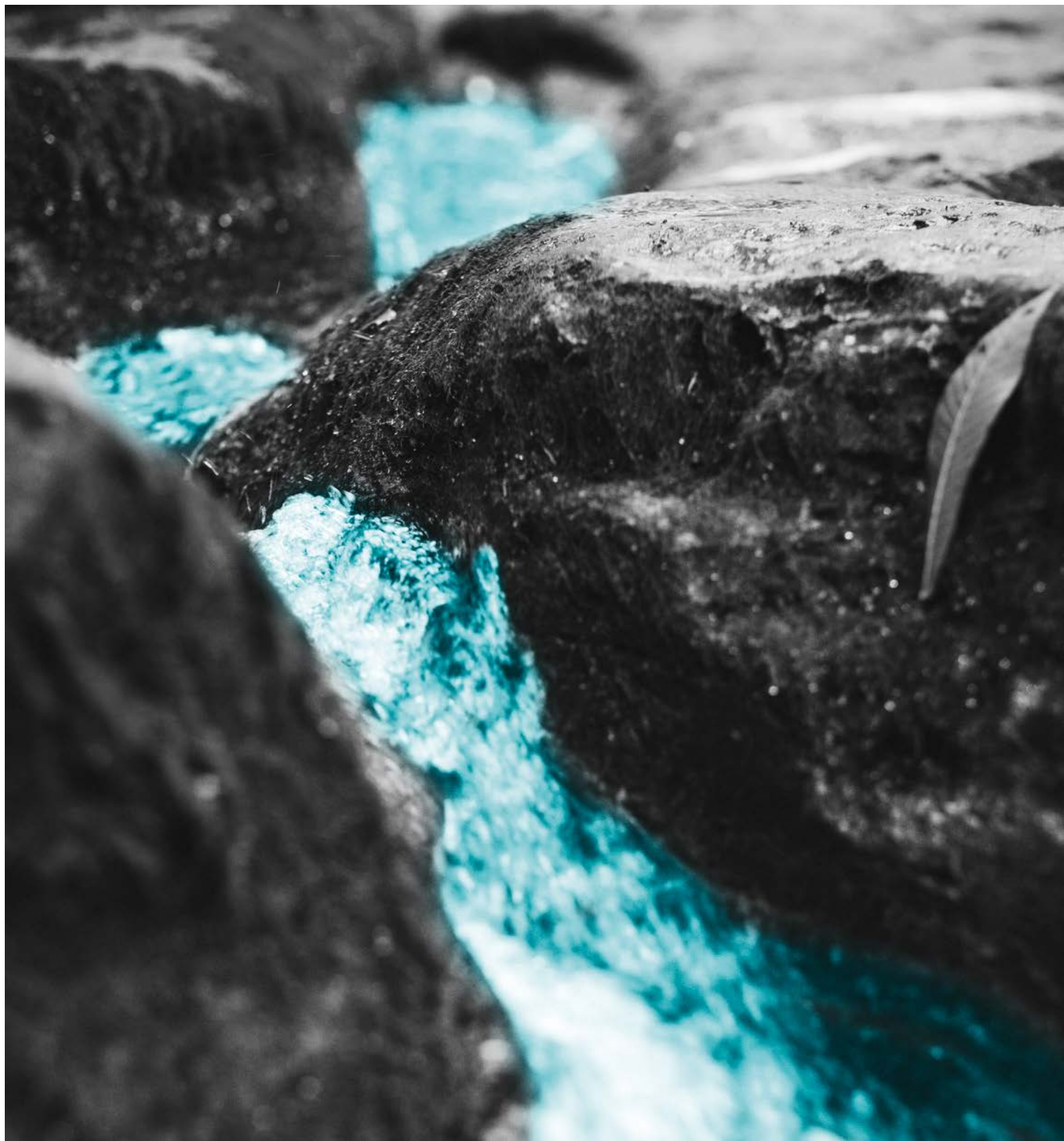

The Bathroom Collection.

Collezione Bagno.

Scopri le collezioni di rubinetteria per il bagno firmate Radomonte. Prodotti Made in Italy di alta qualità, realizzati attraverso l'uso esclusivo dell'acciaio inox, resi unici da un design ricercato e da dettagli preziosi come il vetro di Murano. Un affascinante viaggio sospeso tra creatività e sentimento, per chi ama infondere di bellezza la vita quotidiana.

Discover the bathroom tapware collections by Radomonte. High quality Made in Italy products, made using exclusively of stainless steel, made unique by a refined design and precious details such as Murano glass. A fascinating journey suspended between creativity and feeling, for those who love to infuse with beauty their everyday life.

Toox

L'incontro tra il rigore di geometrie perpendicolari e la leggerezza di linee morbide e circolari.
Una serie dal design moderno e funzionale.

The meeting between the rigor of perpendicular geometries and the lightness of soft and circular lines.
A series with a modern and functional design.







Miscelatore lavabo 2 fori top, inox
spazzolato - TQN33

Deck-mounted 2-hole basin mixer,
brushed steel - TQN33



Set per lavabo a muro 3 fori, bronzo spazzolato PVD - TQN28

3-hole wall-mounted basin set, brushed bronze PVD - TQN28







Miscelatore bidet, carbon spazzolato PVD - TXQ94

Bidet mixer, brushed carbon PVD - TXQ94



Doccia incasso termostatico coassiale con deviatore 3 vie integrato, oro spazzolato PVD - TER3

Miscelatore termostatico con collettore a 3 vie, inox spazzolato - TQN56

Coaxial thermostatic mixer with integrated 3-way diverter, brushed gold PVD - TER3

Thermostatic shower mixer with 3-way manifold, brushed steel - TQN56





Cod. TXQ91

Miscelatore lavabo
Basin mixer



Cod. TXQ92

Miscelatore lavabo medio
Medium basin mixer



Cod. TXQ93

Miscelatore lavabo rialzato
High basin mixer



Cod. TXQ30

Set per lavabo 2 fori
2-hole basin set



Cod. TQN25

Set per lavabo 3 fori
3-hole basin set



Cod. TQN18

Miscelatore lavabo a muro
Wall-mounted basin mixer



Cod. TQN28

Rubinetto lavabo a muro
Wall-mounted basin tap



Cod. TXQ97

Miscelatore lavabo a pavimento
Floor-standing basin mixer



Cod. TXQ94

Miscelatore bidet
Bidet mixer



Cod. TQD81

Set doccia orizzontale termostatico 2 vie
Horizontal thermostatic 2-way mixer



Cod. TQN60

Termostatico con due rubinetti d'arresto
Thermostatic with 2 stop valves



Cod. TXQ5

Miscelatore con deviatore 3 vie
Manual mixer with 3-way diverter



Cod. TQN57

Termostatico con collettore 4 vie
Thermostatic with 4 manifolds



Cod. TQN52

Set vasca orizzontale grande portata
High flow rate thermostatic bath kit



Cod. TXQ16

Bordo vasca 4 fori
4-hole deck-mounted bath set

Cod. PVQ99

Piantana vasca a pavimento
Floor-standing bath mixer

Toox

L'incontro tra il rigore di geometrie perpendicolari e la leggerezza di linee morbide e circolari. Una serie dal design moderno e funzionale.

The meeting between the rigor of perpendicular geometries and the lightness of soft and circular lines. A series with a modern and functional design.

Lavabo / Basin mixer

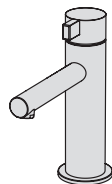

Miscelatore monocomando lavabo senza salterello e scarico
Single lever basin mixer without pop-up waste and drain

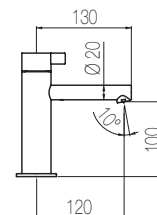
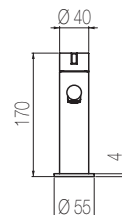

Code **Finishing** **Price**

TXQ91 **S** Acciaio spazz. / Brushed steel €



Lavabo medio / Medium basin mixer

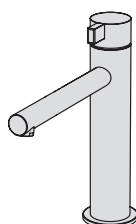

Miscelatore monocomando lavabo medio senza salterello e scarico
Single lever medium basin mixer without pop-up waste and drain

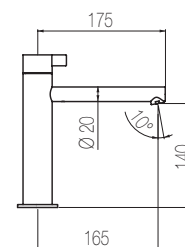
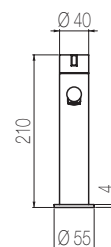

Code **Finishing** **Price**

TXQ92 **S** Acciaio spazz. / Brushed steel €



Lavabo rialzato / High basin mixer

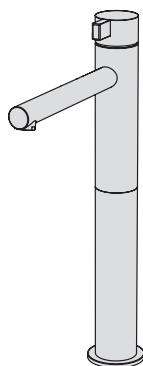

Miscelatore monocomando lavabo rialzato senza salterello e scarico
Single lever high basin mixer without pop-up waste and drain

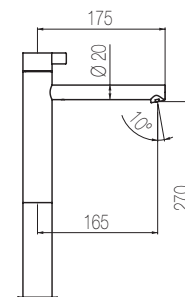
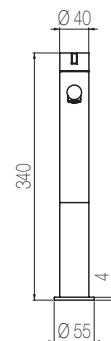

Code **Finishing** **Price**

TXQ93 **S** Acciaio spazz. / Brushed steel €



Bidet / Bidet

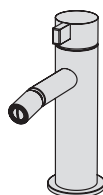

Miscelatore monocomando bidet senza salterello e scarico
Single lever bidet mixer without pop-up waste and drain

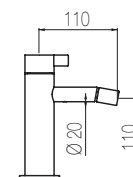
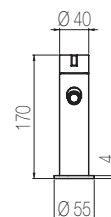

Code **Finishing** **Price**

TXQ94 **S** Acciaio spazz. / Brushed steel €



Miscelatore lavabo mini / Mini basin mixer

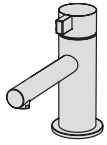

Miscelatore monocomando lavabo mini senza salterello e scarico
Single lever mini basin mixer without pop-up waste and drain

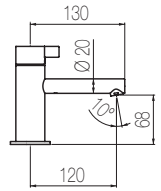
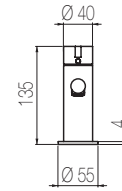

Code **Finishing** **Price**

TQN80 **S** Acciaio spazz. / Brushed steel €



Miscelatore bidet mini / Mini bidet mixer

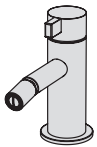

Miscelatore monocomando bidet mini senza salterello e scarico
Single lever mini bidet mixer without pop-up waste and drain

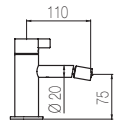
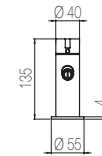

Code **Finishing** **Price**

TQN81 **S** Acciaio spazz. / Brushed steel €



Piantana lavabo / Floor-standing basin mixer

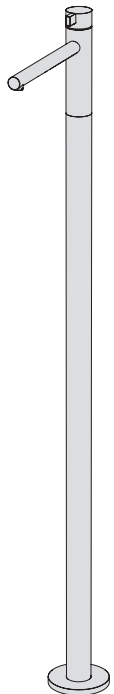

Piantana lavabo senza salterello e scarico
Floor-standing basin mixer without pop-up waste and drain

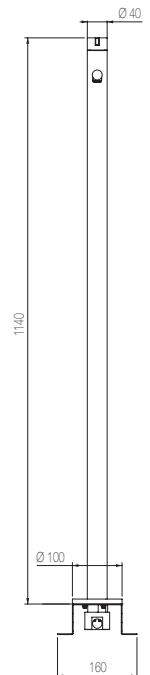
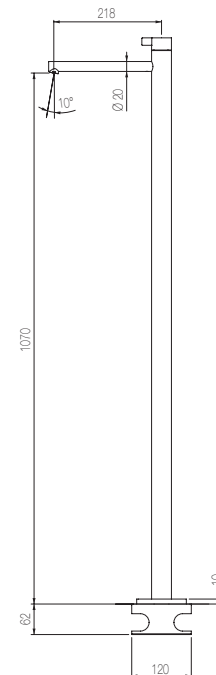

Code **Finishing** **Price**

TXQ97 **S** Acciaio spazz. / Brushed steel €



Parte incasso / Built-in part

Vedi a / See at pg. 258

Code **Finishing** **Price**

INC7 €

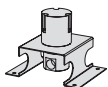

Monoacqua a top / Deck-mounted cold water tap

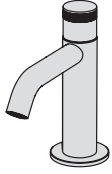

Rubinetto mono-acqua senza salterello e scarico
Tap for cold water only without pop-up waste and drain

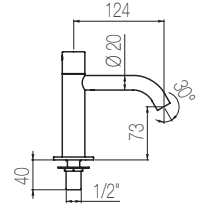
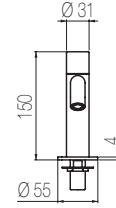

Code **Finishing** **Price**

MONO2 S Acciaio spazz. / Brushed steel €



- S
- L
- CS
- RS
- GS
- BS

Monoacqua a parete / Wall-mounted cold water tap



Rubinetto mono-acqua a parete senza salterello e scarico
Wall-mounted tap for cold water only without pop-up waste and drain

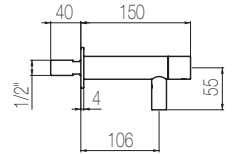
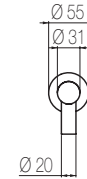

Code **Finishing** **Price**

MONO1 S Acciaio spazz. / Brushed steel €



- S
- L
- CS
- RS
- GS
- BS

Lavabo 2 fori / 2-hole basin group

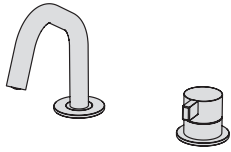

Set per lavabo due fori composto da miscelatore top e bocca di erogazione girevole (160°) senza salterello e scarico

2-hole basin group with remote control on deck and swivel spout (160°) without pop-up waste and drain

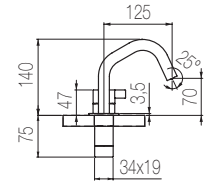
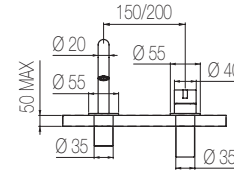

Code **Finishing** **Price**

TQN30 **S** Acciaio spazz. / Brushed steel €



Lavabo 2 fori / 2-hole basin group

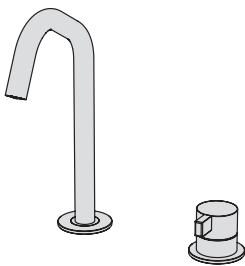

Set per lavabo due fori composto da miscelatore top e bocca di erogazione girevole (160°) senza salterello e scarico

2-hole basin group with remote control on deck and swivel spout (160°) without pop-up waste and drain

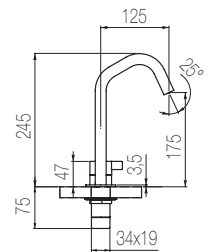
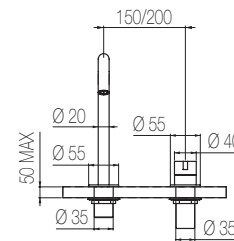

Code **Finishing** **Price**

TQN34 **S** Acciaio spazz. / Brushed steel €



Lavabo 2 fori / 2-hole basin group

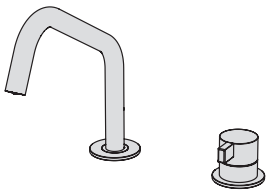

Set per lavabo due fori composto da miscelatore top e bocca di erogazione grande girevole (160°) senza salterello e scarico

2-hole basin group with remote control on deck and big swivel spout (160°) without pop-up waste and drain

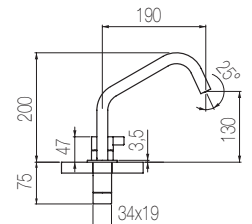
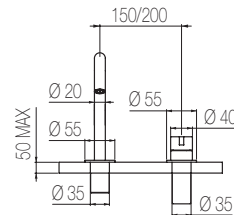

Code **Finishing** **Price**

TQN31 **S** Acciaio spazz. / Brushed steel €



Lavabo 3 fori / 3-hole basin group

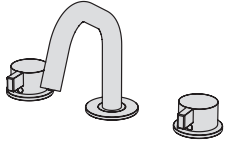

Set per lavabo tre fori composto da due comandi piantana con vitone ceramico e bocca di erogazione girevole (160°) senza salterello e scarico

Three hole basin set with two remote controls with ceramic valves and swivel spout (160°) without pop-up waste and drain

Code Finishing Price

TQN23 S Acciaio spazz. / Brushed steel €

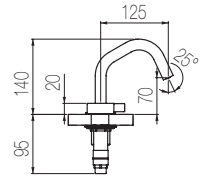
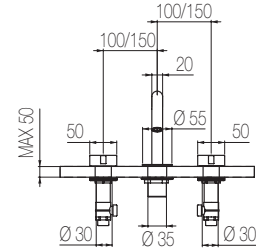

Lavabo 3 fori / 3-hole basin group

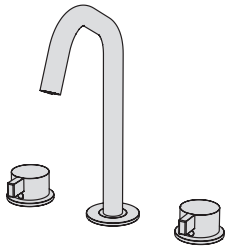

Set per lavabo tre fori composto da due comandi piantana con vitone ceramico e bocca di erogazione girevole (160°) senza salterello e scarico

Three hole basin set with two remote controls with ceramic valves and swivel spout (160°) without pop-up waste and drain

Code Finishing Price

TQN25 S Acciaio spazz. / Brushed steel €

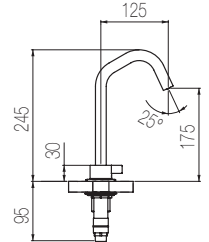
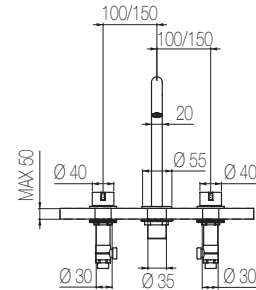

Lavabo 3 fori / 3-hole basin group

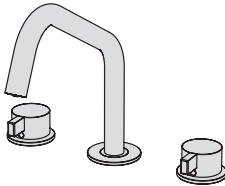

Set per lavabo tre fori composto da due comandi piantana con vitone ceramico e bocca di erogazione girevole (160°) grande senza salterello e scarico

Three hole basin set with two remote controls with ceramic valves and big swivel spout (160°) without pop-up waste and drain

Code Finishing Price

TQN24 S Acciaio spazz. / Brushed steel €

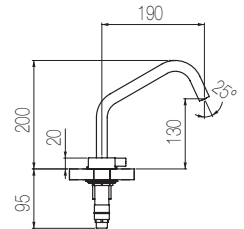
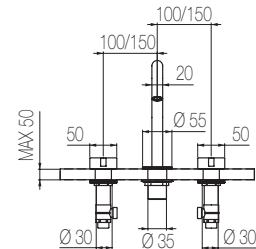

Comando remoto top / Deck-mounted mixer



Miscelatore monocomando top
Single lever deck-mounted mixer

Code Finishing Price

TXQ12 S Acciaio spazz. / Brushed steel €

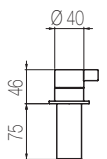
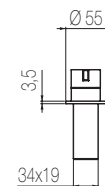

Bocca lavabo top / Deck-mounted spout

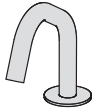

Bocca lavabo top girevole (160°)
Deck-mounted swivel spout (160°) for basin

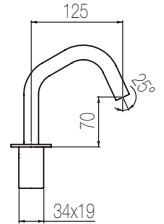
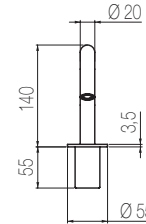

Code Finishing Price

CHT90 S Acciaio spazz. / Brushed steel €



Bocca lavabo top / Deck-mounted spout

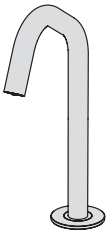

Bocca lavabo top girevole (160°)
Deck-mounted swivel spout (160°) for basin

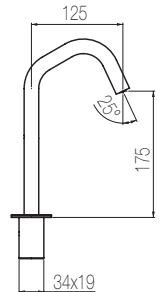
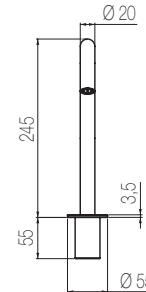

Code Finishing Price

CHT92 S Acciaio spazz. / Brushed steel €



Bocca lavabo top / Deck-mounted spout

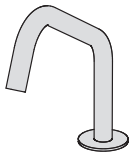

Bocca lavabo top grande girevole (160°)
Deck-mounted big swivel spout (160°) for basin

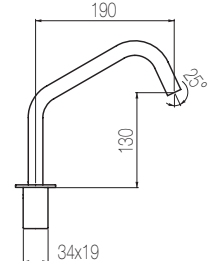
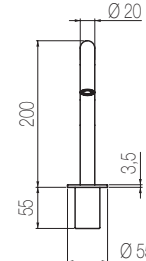

Code Finishing Price

CHT91 S Acciaio spazz. / Brushed steel €



Bocca bidet top / Deck-mounted bidet spout

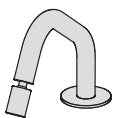

Bocca bidet top girevole (160°) con snodo
Deck-mounted swivel spout (160°) for bidet with swivel junction

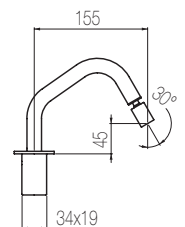
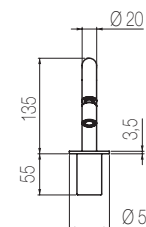

Code Finishing Price

CHB92 S Acciaio spazz. / Brushed steel €



Miscelatore lavabo a muro / Wall-mounted basin mixer

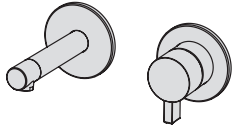

Parte estetica miscelatore lavabo due fori con canna dritta L=100 senza salterello e scarico

External part 2-hole built-in basin mixer with L=100 straight spout without pop-up waste and drain

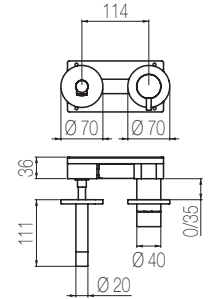
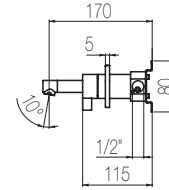

Code Finishing Price

TQN17 S Acciaio spazz. / Brushed steel €



Parte incasso / Built-in part Vedi a / See at pg. 258

Code Finishing Price

INN18 S Acciaio spazz. / Brushed steel €

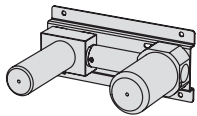

Miscelatore lavabo a muro / Wall-mounted basin mixer

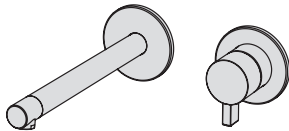

Parte estetica miscelatore lavabo due fori con canna dritta L=190 senza salterello e scarico

External part 2-hole built-in basin mixer with L=190 straight spout without pop-up waste and drain

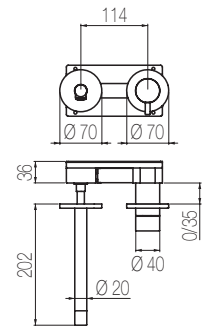
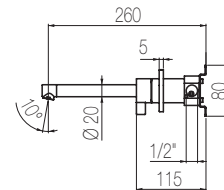

Code Finishing Price

TQN18 S Acciaio spazz. / Brushed steel €



Parte incasso / Built-in part Vedi a / See at pg. 258

Code Finishing Price

INN18 S Acciaio spazz. / Brushed steel €

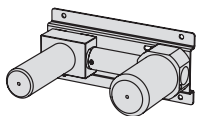

Miscelatore lavabo a muro / Wall-mounted basin mixer

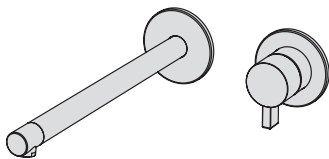

Parte estetica miscelatore lavabo due fori con canna dritta L=250 senza salterello e scarico

External part 2-hole built-in basin mixer with L=250 straight spout without pop-up waste and drain

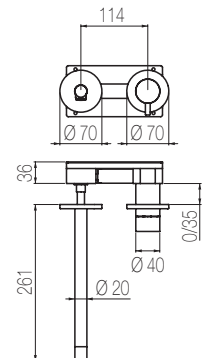
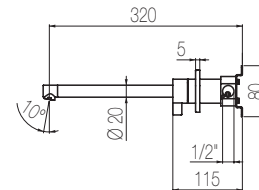

Code Finishing Price

TQN19 S Acciaio spazz. / Brushed steel €



Parte incasso / Built-in part Vedi a / See at pg. 258

Code Finishing Price

INN18 S Acciaio spazz. / Brushed steel €

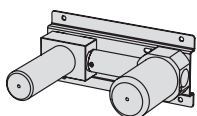

Rubinetto lavabo a muro / Wall-mounted basin tap

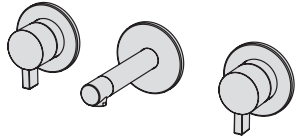

Parte estetica set per lavabo a muro tre fori con canna dritta l=100 mm senza salterello e scarico
External part for 3-hole built-in basin set with l=100 mm straight spout without pop-up waste and drain

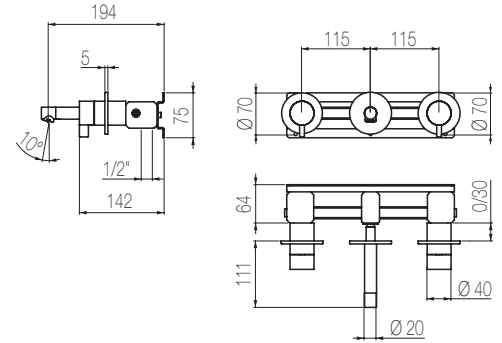

Code Finishing Price

TQN27 S Acciaio spazz. / Brushed steel €



Parte incasso / Built-in part Vedi a / See at pg. 259

Code Finishing Price

INC29 S Acciaio spazz. / Brushed steel €

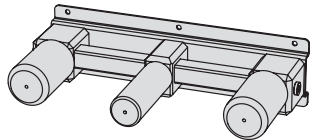

Rubinetto lavabo a muro / Wall-mounted basin tap

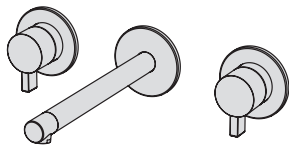

Parte estetica set per lavabo a muro tre fori con canna dritta l=190 mm senza salterello e scarico
External part for 3-hole built-in basin set with l=190 mm straight spout without pop-up waste and drain

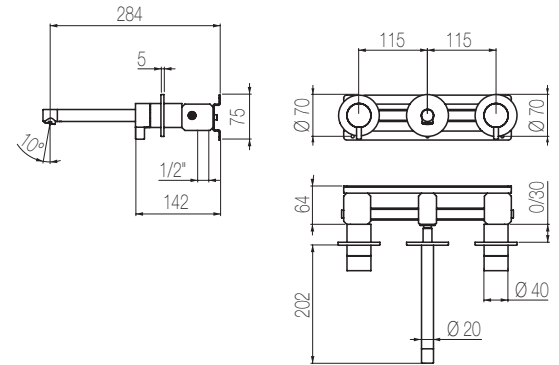

Code Finishing Price

TQN28 S Acciaio spazz. / Brushed steel €



Parte incasso / Built-in part Vedi a / See at pg. 259

Code Finishing Price

INC29 S Acciaio spazz. / Brushed steel €

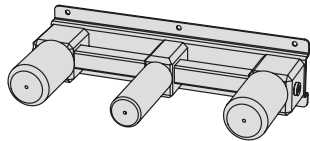

Rubinetto lavabo a muro / Wall-mounted basin tap

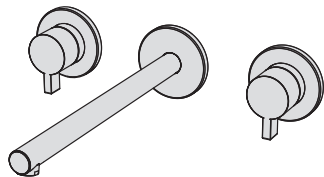

Parte estetica set per lavabo a muro tre fori con canna dritta l=250 mm senza salterello e scarico
External part for 3-hole built-in basin set with l=250 mm straight spout without pop-up waste and drain

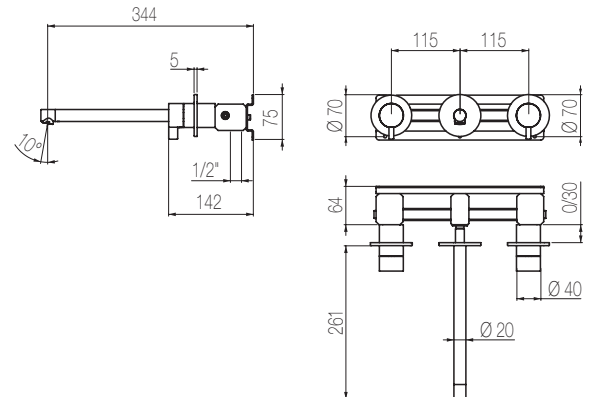

Code Finishing Price

TQN29 S Acciaio spazz. / Brushed steel €



Parte incasso / Built-in part Vedi a / See at pg. 259

Code Finishing Price

INC29 S Acciaio spazz. / Brushed steel €

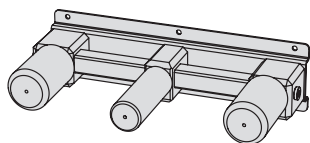

Bocca lavabo a muro / Wall-mounted spout



Bocca lavabo a muro dritta L=100 mm
Straight wall-mounted basin spout L=100 mm

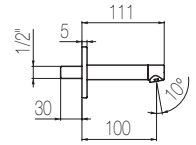

Code **Finishing** **Price**

CHM10 **S** Acciaio spazz. / Brushed steel €



Bocca lavabo a muro / Wall-mounted spout

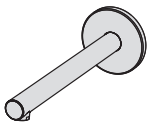

Bocca lavabo a muro dritta L=190 mm
Straight wall-mounted basin spout L=190 mm

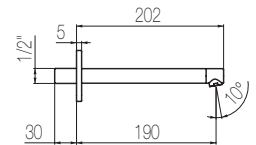
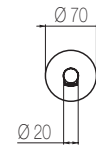

Code **Finishing** **Price**

CHM19 **S** Acciaio spazz. / Brushed steel €



Bocca lavabo a muro / Wall-mounted spout

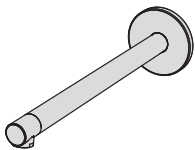

Bocca lavabo a muro dritta L=250 mm
Straight wall-mounted basin spout L=250 mm

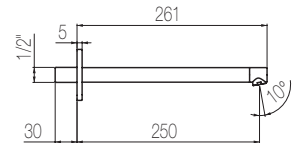
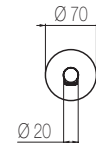

Code **Finishing** **Price**

CHM25 **S** Acciaio spazz. / Brushed steel €



Bocca lavabo a muro / Wall-mounted bidet spout



Bocca bidet a muro con snodo
Wall-mounted bidet spout with swivel junction

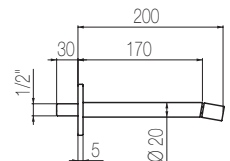
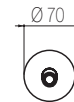

Code **Finishing** **Price**

CHB50 **S** Acciaio spazz. / Brushed steel €



Bocca lavabo a pavimento / Free-standing basin spout

Bocca lavabo con alimentazione a pavimento con canna girevole
Floor-standing swivel basin spout

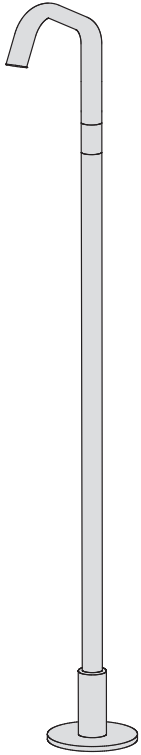

Code	Finishing	Price
CHP90	S Acciaio spazz. / Brushed steel	€

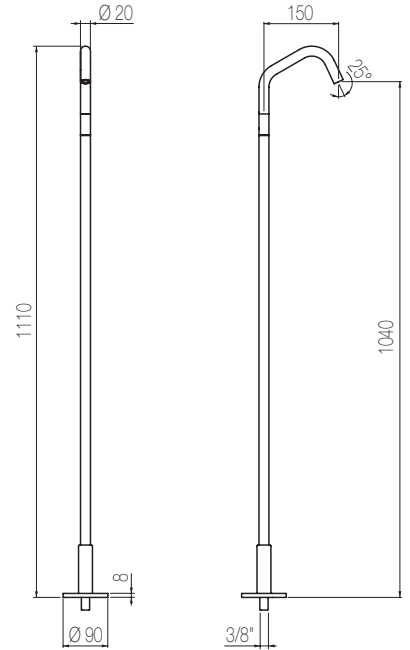

Bocca lavabo a pavimento / Free-standing basin spout

Bocca lavabo con alimentazione a pavimento con canna girevole grande
Big floor-standing swivel basin spout

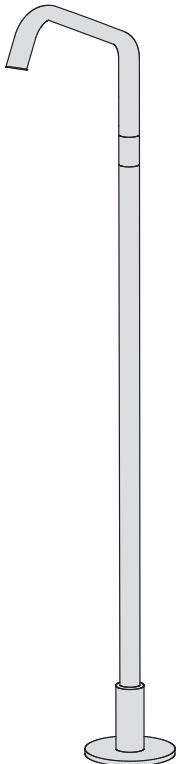

Code	Finishing	Price
CHP91	S Acciaio spazz. / Brushed steel	€

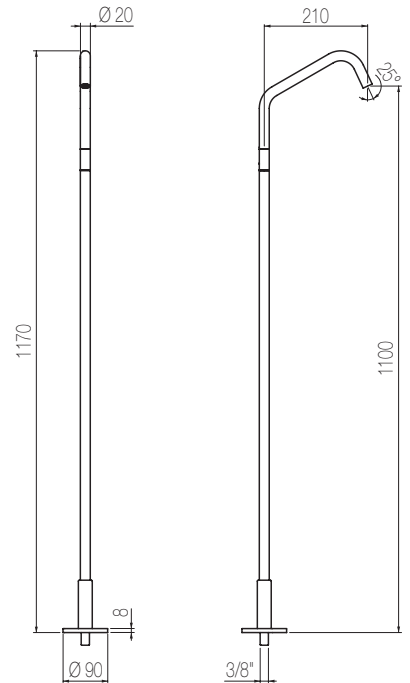

Bocca lavabo a soffitto / Ceiling-mounted basin spout

Bocca lavabo con alimentazione a soffitto
Ceiling-mounted basin spout

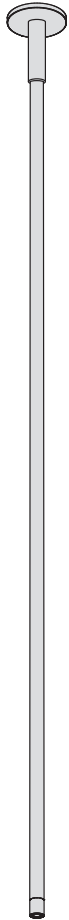

Code	Finishing	Price
CHS1	S Acciaio spazz. / Brushed steel	€

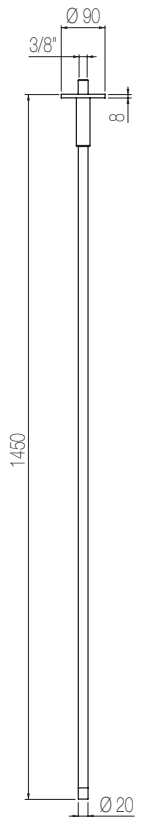

Miscelatore a parete / Wall-mounted mixer

Parte estetica miscelatore monocomando incasso a parete
External part for wall-mounted single lever mixer

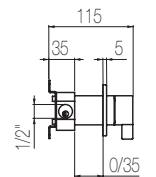
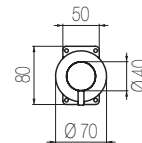

Code	Finishing	Price
TXQ8	S Acciaio spazz. / Brushed steel	€



Parte incasso / Built-in part Vedi a / See at pg. 260

Code	Finishing	Price
INN8	S Acciaio spazz. / Brushed steel	€



Miscelatore termostatico a parete / Wall-mounted thermostatic mixer



Parte estetica miscelatore termostatico coassiale con regolatore di portata

External part for coaxial thermostatic mixer with flow regulator

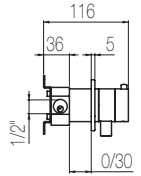
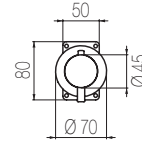

Code	Finishing	Price
------	-----------	-------

TER1	S Acciaio spazz. / Brushed steel	€
------	----------------------------------	---



Parte incasso / Built-in part Vedi a / See at pg.261

Code	Finishing	Price
------	-----------	-------

INN1	S Acciaio spazz. / Brushed steel	€
------	----------------------------------	---



Deviatore 2 vie / 2-way diverter



Parte estetica per comando deviatore incasso a 2 vie

External part for built-in 2-ways diverter

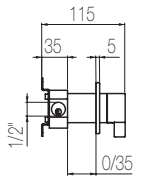
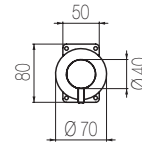

Code	Finishing	Price
------	-----------	-------

TXQ10	S Acciaio spazz. / Brushed steel	€
-------	----------------------------------	---



Parte incasso / Built-in part Vedi a / See at pg.261

Code	Finishing	Price
------	-----------	-------

INN10	S Acciaio spazz. / Brushed steel	€
-------	----------------------------------	---



Deviatore 3 vie / 3-way diverter



Parte estetica per comando deviatore incasso a 3 vie

External part for built-in 3-ways diverter

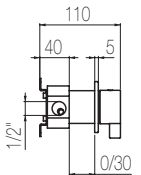
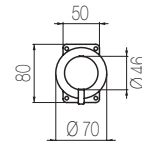

Code	Finishing	Price
------	-----------	-------

TXQ11	S Acciaio spazz. / Brushed steel	€
-------	----------------------------------	---



Parte incasso / Built-in part Vedi a / See at pg.262

Code	Finishing	Price
------	-----------	-------

INN11	S Acciaio spazz. / Brushed steel	€
-------	----------------------------------	---



Doccia incasso con deviatore 2 vie integrato / Shower mixer with integrated 2-way diverter

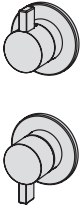

Parte estetica per miscelatore doccia incasso meccanico con deviatore 2 vie integrato.

Adatto per installazione verticale e orizzontale

External part for built-in manual shower mixer with integrated 2-ways diverter.

For both vertical and horizontal installation

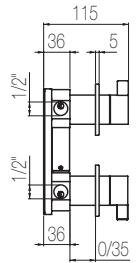
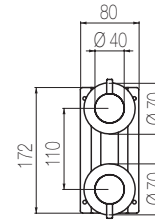

Code	Finishing	Price
------	-----------	-------

TXQ9	S Acciaio spazz. / Brushed steel	€
------	----------------------------------	---

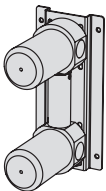

Parte incasso verticale / Vertical Built-in part

Vedi a / See at pg. 262

Code	Finishing	Price
------	-----------	-------

INN9	S Acciaio spazz. / Brushed steel	€
------	----------------------------------	---

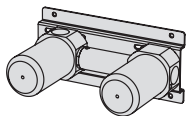

Parte incasso orizzontale / Horizontal Built-in part

Vedi a / See at pg. 262

Code	Finishing	Price
------	-----------	-------

INN12	S Acciaio spazz. / Brushed steel	€
-------	----------------------------------	---



Doccia incasso con deviatore 3 vie integrato / Shower mixer with integrated 3-way diverter



Parte estetica per miscelatore doccia incasso meccanico con deviatore 3 vie integrato.

Adatto per installazione verticale e orizzontale

External part for built-in manual shower mixer with integrated 3-ways diverter.

For both vertical and horizontal installation

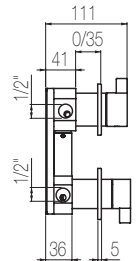
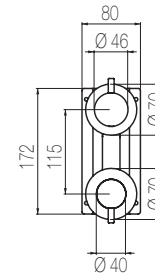

Code	Finishing	Price
------	-----------	-------

TXQ5	S Acciaio spazz. / Brushed steel	€
------	----------------------------------	---

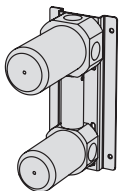

Parte incasso verticale / Vertical Built-in part

Vedi a / See at pg. 263

Code	Finishing	Price
------	-----------	-------

INN5	S Acciaio spazz. / Brushed steel	€
------	----------------------------------	---

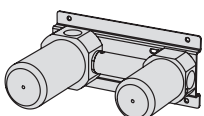

Parte incasso orizzontale / Horizontal Built-in part

Vedi a / See at pg. 263

Code	Finishing	Price
------	-----------	-------

INN13	S Acciaio spazz. / Brushed steel	€
-------	----------------------------------	---



Doccia incasso termostatico con deviatore 2 vie integrato Thermostatic shower mixer with integrated 2-way diverter

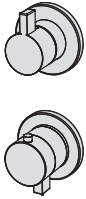

Parte estetica per miscelatore doccia incasso termostatico con deviatore 2 vie integrato.
Adatto per installazione verticale e orizzontale
External part for built-in thermostatic shower mixer with integrated 2-ways diverter.
For both vertical and horizontal installation

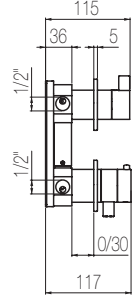
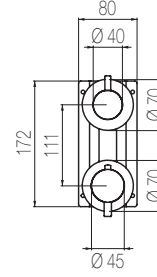

Code	Finishing	Price
TER2	S Acciaio spazz. / Brushed steel	€

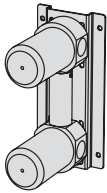

Parte incasso verticale / Vertical Built-in part

Vedi a / See at pg. 264

Code	Finishing	Price
INN2	S Acciaio spazz. / Brushed steel	€

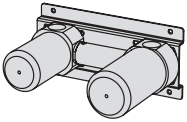

Parte incasso orizzontale / Horizontal Built-in part

Vedi a / See at pg. 264

Code	Finishing	Price
INN14	S Acciaio spazz. / Brushed steel	€



Doccia incasso termostatico con deviatore 3 vie integrato Thermostatic shower mixer with integrated 3-way diverter

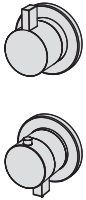

Parte estetica per miscelatore doccia incasso termostatico con deviatore 3 vie integrato.
Adatto per installazione verticale e orizzontale
External part for built-in thermostatic shower mixer with integrated 3-ways diverter.
For both vertical and horizontal installation

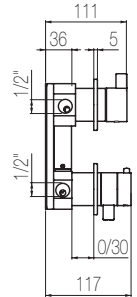
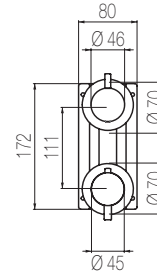

Code	Finishing	Price
TER3	S Acciaio spazz. / Brushed steel	€

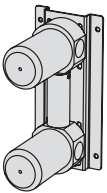

Parte incasso / Built-in part

Vedi a / See at pg. 265

Code	Finishing	Price
INN3	S Acciaio spazz. / Brushed steel	€



Set doccia orizzontale 2 vie / Horizontal shower set with 2-ways diverter

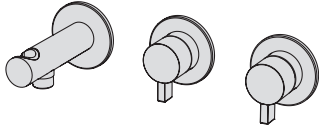

Parte estetica per miscelatore doccia incasso meccanico con deviatore 2 vie integrato e presa acqua con supporto, per installazione orizzontale
 External part for manual shower mixer with integrated 2-ways diverter and water connection with hand shower holder

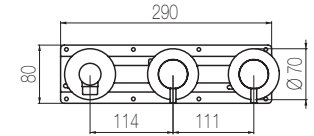

Da integrare con doccetta e flessibile a scelta. **Vedi a pg. 294**
 To be completed with hand shower and flexible hose of your choice.
See at pg. 294

Code **Finishing** **Price**

TQD80 **S** Acciaio spazz. / Brushed steel €

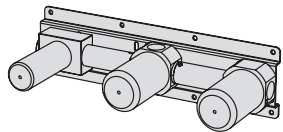
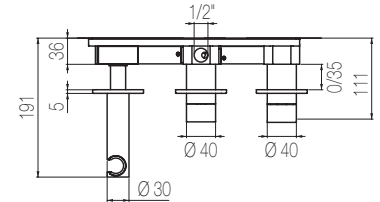

Parte incasso / Built-in part **Vedi a / See at** pg. 266

Code **Finishing** **Price**

INN16 **S** Acciaio spazz. / Brushed steel €



Set doccia orizzontale termostatico 2 vie / Horizontal thermostatic shower set with 2-ways diverter

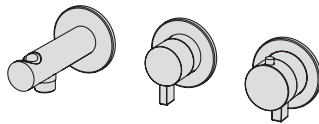

Parte estetica per miscelatore doccia incasso termostatico con deviatore 2 vie integrato e presa acqua con supporto, per installazione orizzontale
 External part for thermostatic shower mixer with integrated 2-ways diverter and water connection with hand shower holder, for horizontal installation

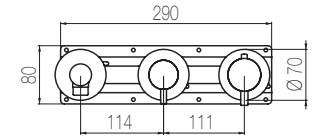

Da integrare con doccetta e flessibile a scelta. **Vedi a pg. 294**
 To be completed with hand shower and flexible hose of your choice.
See at pg. 294

Code **Finishing** **Price**

TQD81 **S** Acciaio spazz. / Brushed steel €

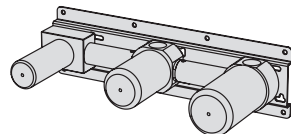
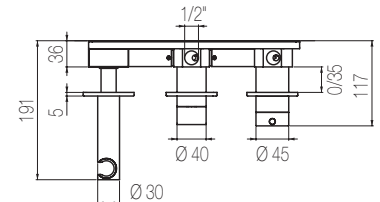

Parte incasso / Built-in part **Vedi a / See at** pg. 266

Code **Finishing** **Price**

INN17 **S** Acciaio spazz. / Brushed steel €



Set doccia orizzontale 3 vie / Horizontal shower set with 3-ways diverter

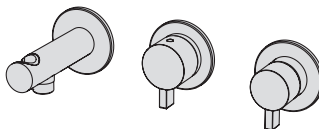

Parte estetica per miscelatore doccia incasso meccanico con deviatore 3 vie integrato e presa acqua con supporto, per installazione orizzontale
 External part for manual shower mixer with integrated 3-ways diverter and water connection with hand shower holder, for horizontal installation

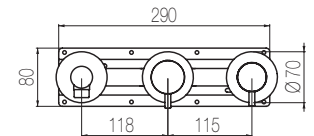

Da integrare con doccetta e flessibile a scelta. **Vedi a pg. 294**
 To be completed with hand shower and flexible hose of your choice.
See at pg. 294

Code **Finishing** **Price**

TQD86 **S** Acciaio spazz. / Brushed steel €

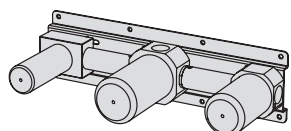
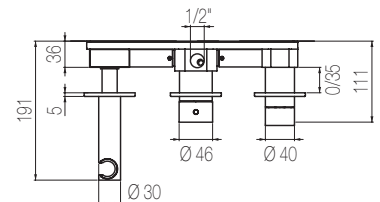

Parte incasso / Built-in part **Vedi a / See at** pg. 266

Code **Finishing** **Price**

INN19 **S** Acciaio spazz. / Brushed steel €



Set doccia orizzontale termostatico 3 vie Horizontal thermostatic shower set with 3-ways diverter

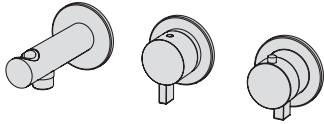

Parte estetica per miscelatore doccia incasso termostatico con deviatore 3 vie integrato e presa acqua con supporto, per installazione orizzontale
External part for thermostatic shower mixer with integrated 3-ways diverter and water connection with hand shower holder, for horizontal installation

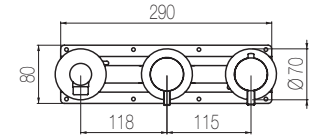

Da integrare con doccetta e flessibile a scelta. **Vedi a pg. 294**
To be completed with hand shower and flexible hose of your choice.
See at pg. 294

Code Finishing Price

TQD87 S Acciaio spazz. / Brushed steel €



Parte incasso / Built-in part **Vedi a / See at** pg. 267

Code Finishing Price

INN20 S Acciaio spazz. / Brushed steel €

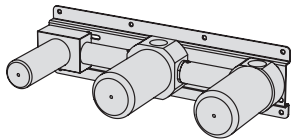
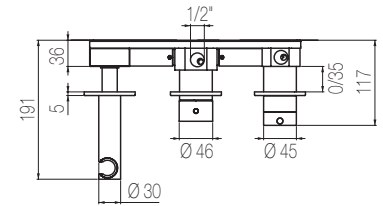

Set doccia termostatico con 2 rubinetti d'arresto / Thermostatic shower set with 2 stop valves

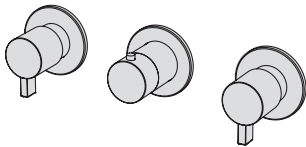

Parte esterna per miscelatore termostatico incasso a muro con due rubinetti di arresto - raccordi da 3/4"
External part for thermostatic built-in mixer with two stop valves - 3/4" connections

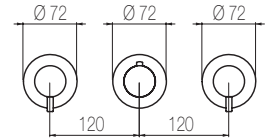

Code Finishing Price

TQN60 S Acciaio spazz. / Brushed steel €



Parte incasso / Built-in part **Vedi a / See at** pg. 267

Code Finishing Price

INN60 S Acciaio spazz. / Brushed steel €

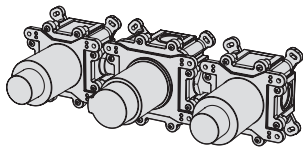
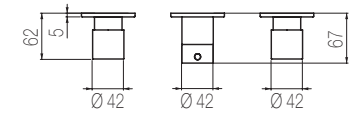

Set doccia termostatico orizzontale a grande portata High flow rate horizontal thermostatic set

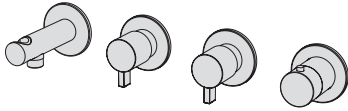

Parte estetica kit doccia orizzontale incasso a muro formato da miscelatore termostatico, collettore 2 vie, rubinetto di arresto e presa acqua con supporto, con raccordi da 3/4"

External part for wall-mounted horizontal shower group made of thermostatic mixer, 2-ways manifold, stop valve, water connection with holder, with 3/4" connections

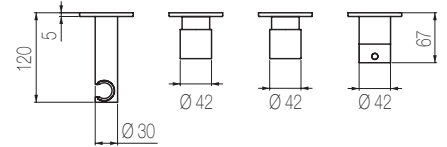
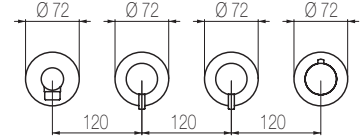

Da integrare con doccetta e flessibile a scelta. **Vedi a pg. 294**

To be completed with hand shower and flexible hose of your choice.

See at pg. 294

Code	Finishing	Price
------	-----------	-------

TQN51 S Acciaio spazz. / Brushed steel €

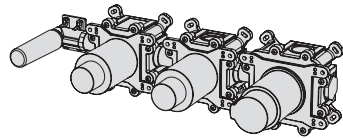

Parte incasso / Built-in part

Vedi a / See at pg. 267

Code	Finishing	Price
------	-----------	-------

INN51 S Acciaio spazz. / Brushed steel €



Termostatico con collettore 2 vie / Thermostatic mixer with 2 manifolds

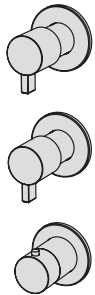

Parte esterna per miscelatore termostatico incasso a muro con collettore 2 vie - raccordi da 3/4"

Adatto per installazione verticale e orizzontale

External part for thermostatic built-in mixer with 2-ways manifold - 3/4" connections.

For both vertical and horizontal installation

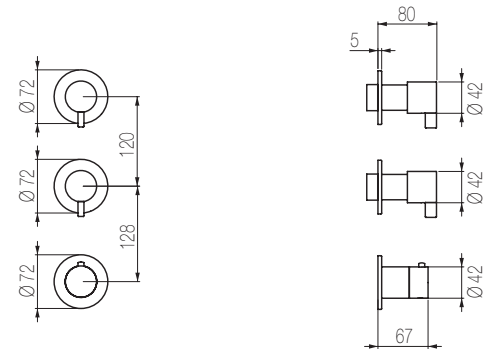

Code	Finishing	Price
------	-----------	-------

TQN55 S Acciaio spazz. / Brushed steel €

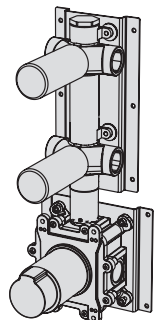

Parte incasso / Built-in part

Vedi a / See at pg. 268

Code	Finishing	Price
------	-----------	-------

INN55 S Acciaio spazz. / Brushed steel €



Termostatico con collettore 3 vie / Thermostatic mixer with 3 manifolds

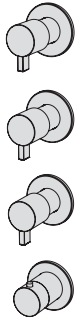

Parte esterna per miscelatore termostatico incasso a muro con collettore 3 vie - raccordi da 3/4".

Adatto per installazione verticale e orizzontale

External part for thermostatic built-in mixer with 3-ways manifold - 3/4" connections.

For both vertical and horizontal installation

Code	Finishing	Price
------	-----------	-------

TQN56	S Acciaio spazz. / Brushed steel	€
--------------	---	---

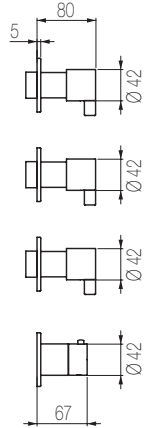
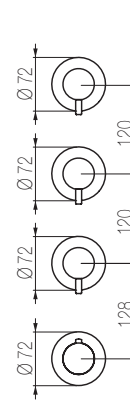

Parte incasso / Built-in part

Vedi a / See at pg. 268

Code	Finishing	Price
------	-----------	-------

INN56	S Acciaio spazz. / Brushed steel	€
--------------	---	---

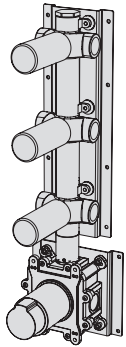

Termostatico con collettore 4 vie / Thermostatic mixer with 4 manifolds

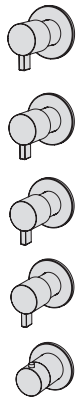

Parte esterna per miscelatore termostatico incasso a muro con collettore 4 vie - raccordi da 3/4".

Adatto per installazione verticale e orizzontale

External part for thermostatic built-in mixer with 4-ways manifold - 3/4" connections.

For both vertical and horizontal installation

Code	Finishing	Price
------	-----------	-------

TQN57	S Acciaio spazz. / Brushed steel	€
--------------	---	---

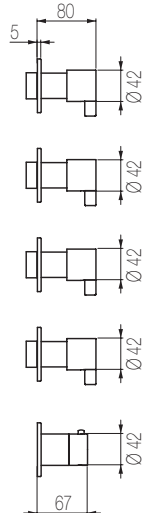
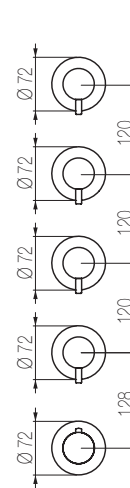

Parte incasso / Built-in part

Vedi a / See at pg. 268

Code	Finishing	Price
------	-----------	-------

INN57	S Acciaio spazz. / Brushed steel	€
--------------	---	---

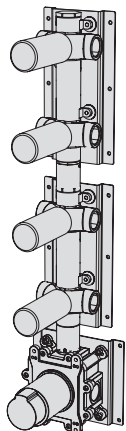

Termostatico con collettore 5 vie / Thermostatic mixer with 5 manifolds

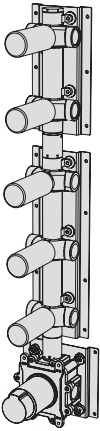
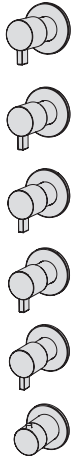

Parte esterna per miscelatore termostatico incasso a muro con collettore 5 vie - raccordi da 3/4".

Adatto per installazione verticale e orizzontale

External part for thermostatic built-in mixer with 5-ways manifold - 3/4" connections.

For both vertical and horizontal installation

Code	Finishing	Price
------	-----------	-------

TQN58	S Acciaio spazz. / Brushed steel	€
--------------	---	---

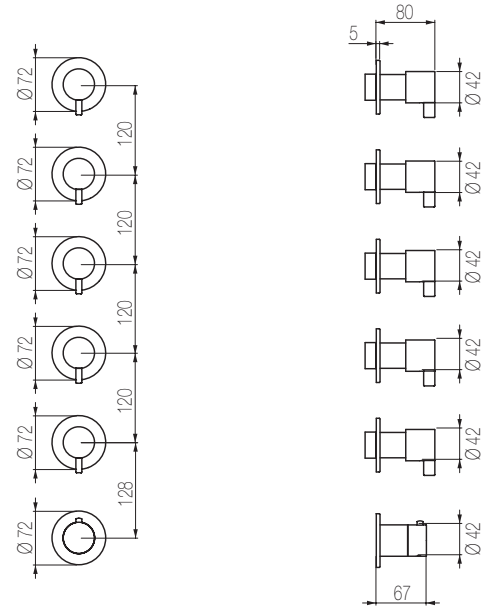

Parte incasso / Built-in part

Vedi a / See at pg. 269

Code	Finishing	Price
------	-----------	-------

INN58	S Acciaio spazz. / Brushed steel	€
--------------	---	---



Set vasca orizzontale 2 vie / Horizontal bath set with 2-ways diverter

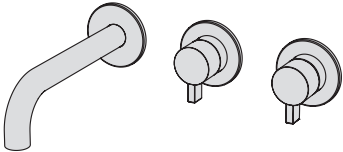

Parte estetica per miscelatore vasca incasso meccanico con deviatore 2 vie integrato e bocca di erogazione fissa L=190 mm, per installazione orizzontale

External part for manual bath mixer with integrated 2-ways diverter and L=190 mm fixed spout, for horizontal installation

Code	Finishing	Price
------	-----------	-------

TQV82	S Acciaio spazz. / Brushed steel	€
--------------	---	---

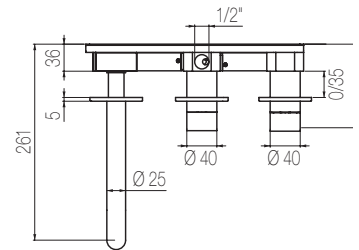
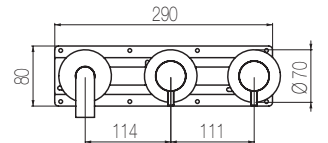

Parte incasso / Built-in part

Vedi a / See at pg. 266

Code	Finishing	Price
------	-----------	-------

INN16	S Acciaio spazz. / Brushed steel	€
--------------	---	---

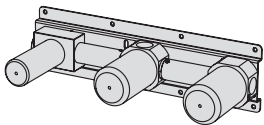

Set vasca orizzontale termostatico 2 vie / Horizontal thermostatic bath set with 2-ways diverter

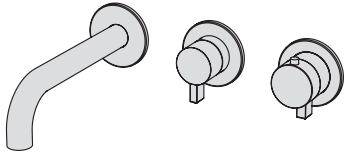

Parte estetica per miscelatore vasca incasso termostatico con deviatore 2 vie integrato e bocca di erogazione fissa L=190 mm, per installazione orizzontale

External part for thermostatic bath mixer with integrated 2-ways diverter and L=190 mm fixed spout, for horizontal installation

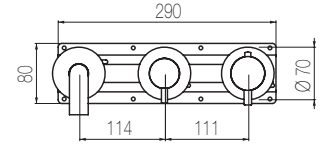

Code Finishing Price

TQV84 S Acciaio spazz. / Brushed steel €



Parte incasso / Built-in part Vedi a / See at pg. 266

Code Finishing Price

INN17 S Acciaio spazz. / Brushed steel €

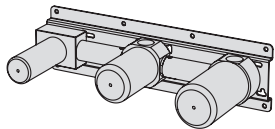
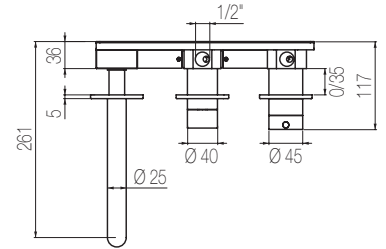

Set vasca orizzontale 3 vie / Horizontal bath set with 3-ways diverter

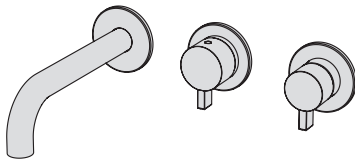

Parte estetica per miscelatore vasca incasso meccanico con deviatore 3 vie integrato e bocca di erogazione fissa L=190 mm, per installazione orizzontale

External part for manual bath mixer with integrated 3-ways diverter and L=190 mm fixed spout, for horizontal installation

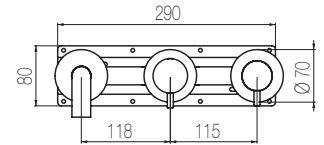

Code Finishing Price

TQV88 S Acciaio spazz. / Brushed steel €



Parte incasso / Built-in part Vedi a / See at pg. 266

Code Finishing Price

INN19 S Acciaio spazz. / Brushed steel €

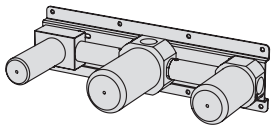
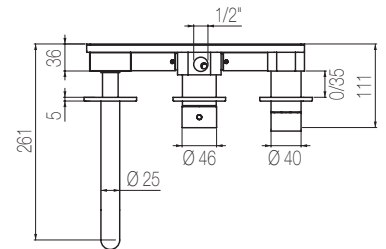

Set vasca orizzontale termostatico 3 vie / Horizontal thermostatic bath set with 3-ways diverter

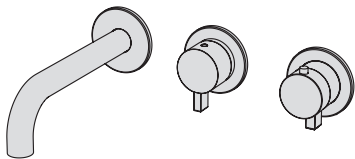

Parte estetica per miscelatore vasca incasso termostatico con deviatore 3 vie integrato e bocca di erogazione fissa L=190 mm, per installazione orizzontale

External part for thermostatic bath mixer with integrated 3-ways diverter and L=190 mm fixed spout, for horizontal installation

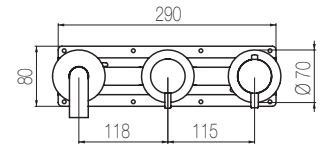

Code Finishing Price

TQV90 S Acciaio spazz. / Brushed steel €



Parte incasso / Built-in part Vedi a / See at pg. 268

Code Finishing Price

INN20 S Acciaio spazz. / Brushed steel €

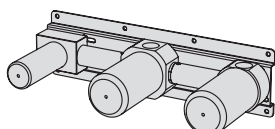
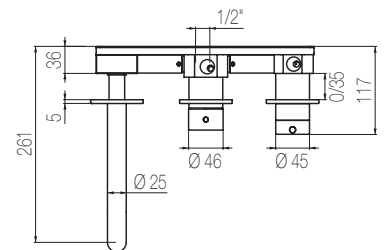

Set vasca termostatico orizzontale a grande portata / High flow rate horizontal bath set

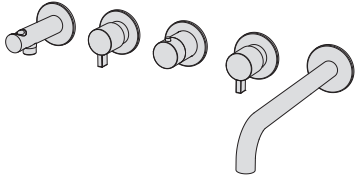

Parte estetica per kit vasca orizzontale incasso a muro formato da miscelatore termostatico, bocca di erogazione fissa, due rubinetti di arresto e presa acqua con supporto, con raccordi da 3/4"

External part for wall-mounted horizontal bath group made of thermostatic mixer, fixed spout, 2 stop valves, and water connection with fixed shower holder, with 3/4" connections

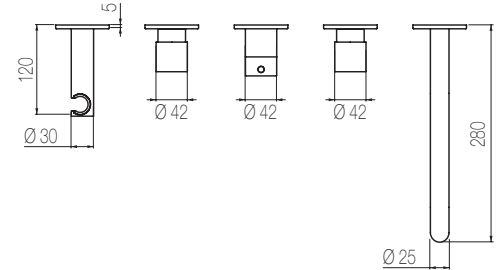
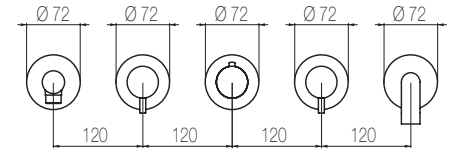

Da integrare con doccetta e flessibile a scelta. **Vedi a pg. 294**

To be completed with hand shower and flexible hose of your choice.

See at pg. 294

Code **Finishing** **Price**

TQN52 **S** Acciaio spazz. / Brushed steel €

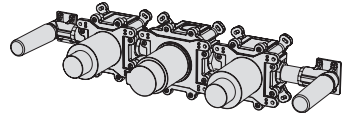

Parte incasso / Built-in part **Vedi a / See at** pg. 269

Code **Finishing** **Price**

INN52 **S** Acciaio spazz. / Brushed steel €



Bocca vasca / Bath spout

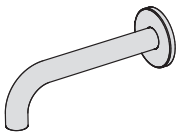

Bocca vasca a muro l=190 mm
Wall-mounted bath spout l=190 mm

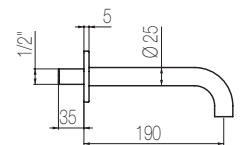
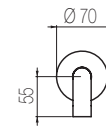

Code **Finishing** **Price**

CHV19 **S** Acciaio spazz. / Brushed steel €



Bocca vasca / Bath spout

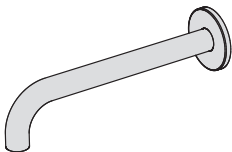

Bocca vasca a muro l=250 mm
Wall-mounted bath spout l=250 mm

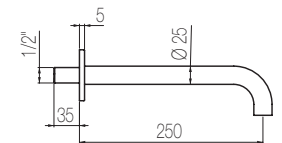
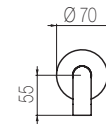

Code **Finishing** **Price**

CHV25 **S** Acciaio spazz. / Brushed steel €



Piantana vasca a pavimento / Free-standing bath mixer

Parte estetica per piantana vasca Ø60 canna a ponte con doccetta

External part for free-standing bath group Ø60 with bridge-shaped spout and hand shower

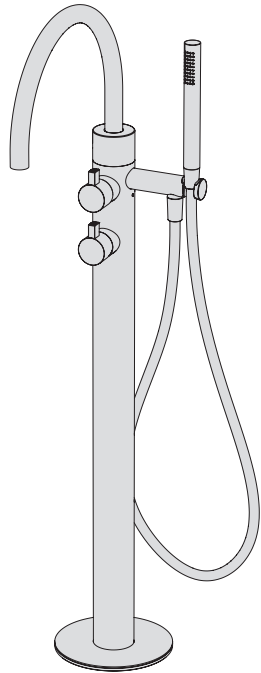

Code	Finishing	Price
PVQ99	S Acciaio spazz. / Brushed steel	€

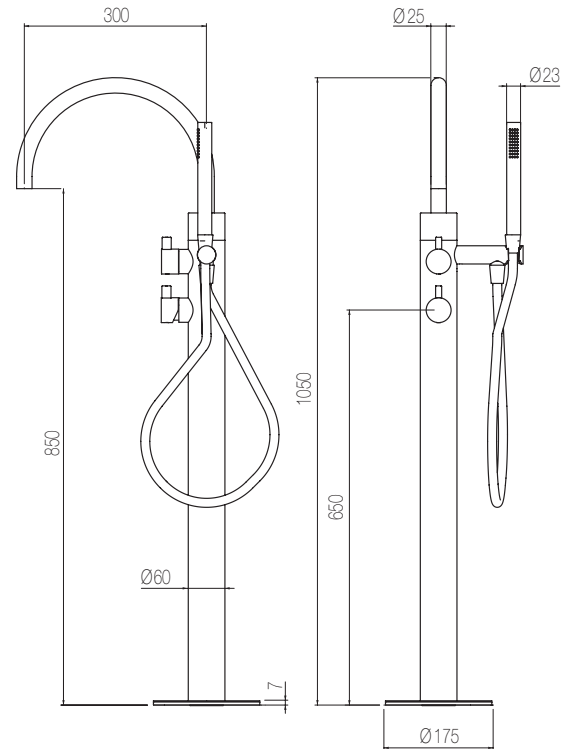

Parte incasso / Built-in part

Vedi a / See at pg. 269

Code	Finishing	Price
INV2		€



Piantana vasca a pavimento / Free-standing bath mixer

Parte estetica per piantana vasca Ø40 canna a ponte con doccetta

External part for free-standing bath group Ø40 with bridge-shaped spout and hand shower

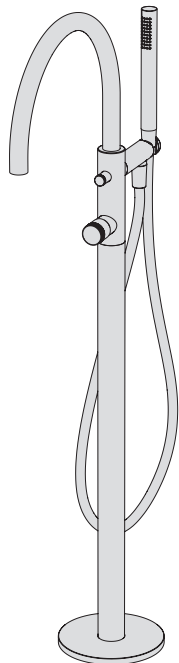

Code	Finishing	Price
PVN3	S Acciaio spazz. / Brushed steel	€

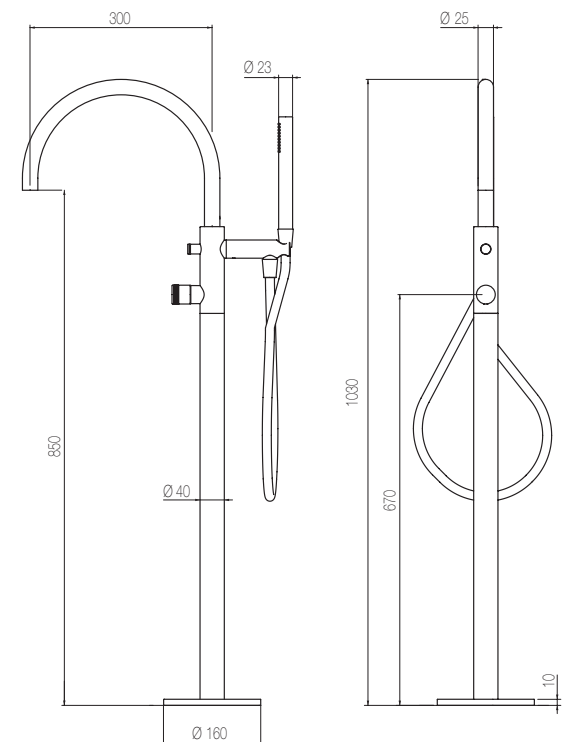

Parte incasso / Built-in part

Vedi a / See at pg. 270

Code	Finishing	Price
INV3		€

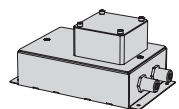

Bocca vasca a pavimento / Floor-mounted bath spout

Bocca vasca con alimentazione a pavimento
Floor-mounted bath spout

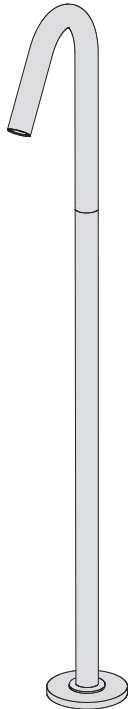

Code	Finishing	Price
CHV1	S Acciaio spazz. / Brushed steel	€

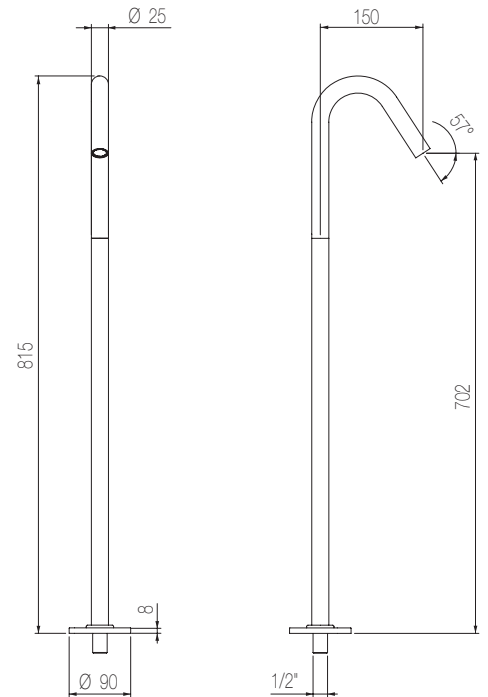

Bordo vasca 3 fori / 3-hole bath group

Kit bordo vasca 3 fori con comando deviatore 2 vie
3-hole bath group on deck with 2 ways diverter

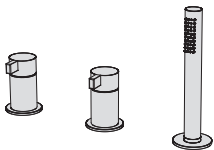

Code	Finishing	Price
TXQ14	S Acciaio spazz. / Brushed steel	€

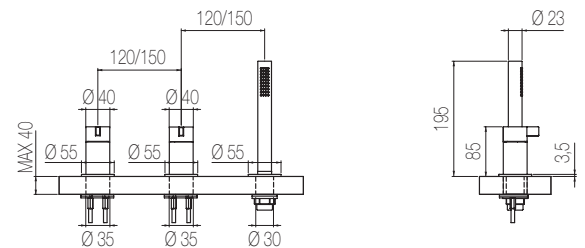

Bordo vasca 4 fori / 4-hole bath group

Kit bordo vasca 4 fori con comando deviatore 2 vie e
bocca di erogazione
4-hole bath group on deck with 2 ways diverter and
spout

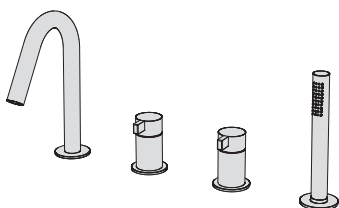

Code	Finishing	Price
TXQ16	S Acciaio spazz. / Brushed steel	€

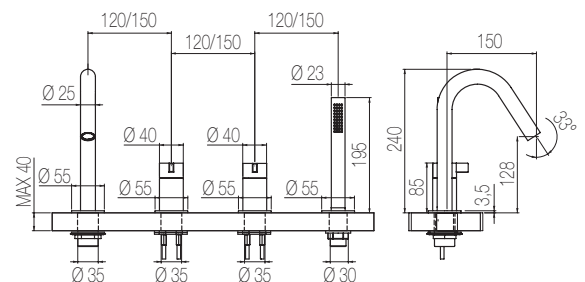

Piastra per bordo vasca 3 fori / 3-hole plate for bath group

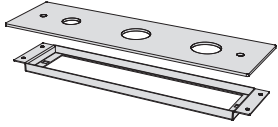

Piastra per bordo vasca ispezionabile 3 fori con telaio.
Obbligatoria nel caso di acquisto della cassetta
incasso per bordo vasca

3-hole plate for inspectable bath group with frame.
Mandatory if the built-in box for bath group is
purchased

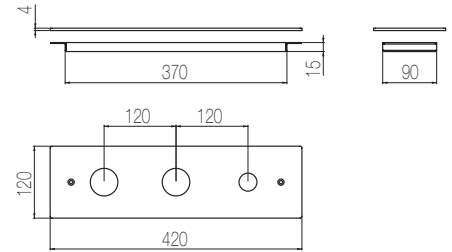

Code	Finishing	Price
VT3	S Acciaio spazz. / Brushed steel	€



Piastra per bordo vasca 4 fori / 4-hole plate for bath group

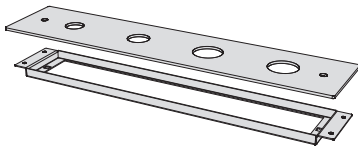

Piastra per bordo vasca ispezionabile 4 fori con telaio.
Obbligatoria nel caso di acquisto della cassetta
incasso per bordo vasca

4-hole plate for inspectable bath group with frame.
Mandatory if the built-in box for bath group is
purchased

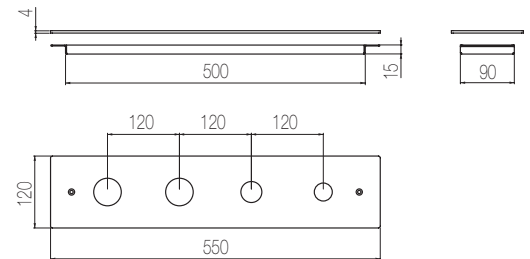

Code	Finishing	Price
VT4	S Acciaio spazz. / Brushed steel	€



Cassetta per bordo vasca 3 fori / Built-in box for 3-hole bath group

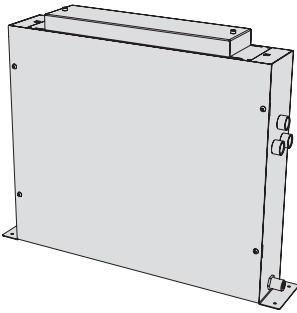

Cassetta incasso per bordo vasca 3 fori con raccordo
per drenaggio acqua

Built-in box for 3-hole bath group with drain
connection

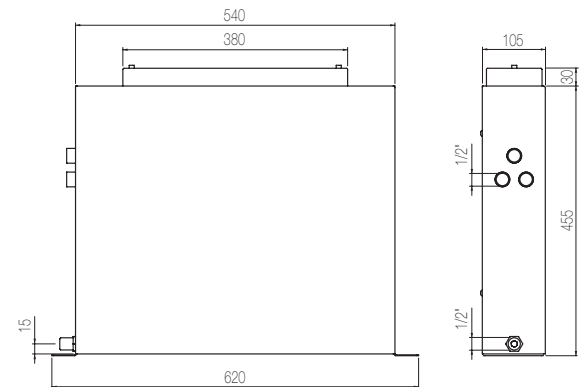

Code	Finishing	Price
VC3		€

Cassetta per bordo vasca 4 fori / Built-in box for 4-hole bath group

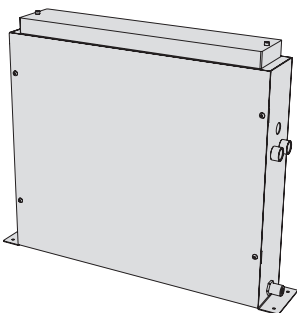

Cassetta incasso per bordo vasca 4 fori con raccordo
per drenaggio acqua

Built-in box for 4-hole bath group with drain
connection

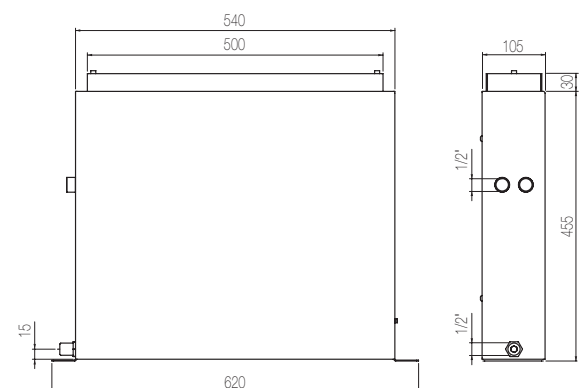

Code	Finishing	Price
VC4		€

Idroscopino per pulizia personale / Hydrobrush for personal hygiene

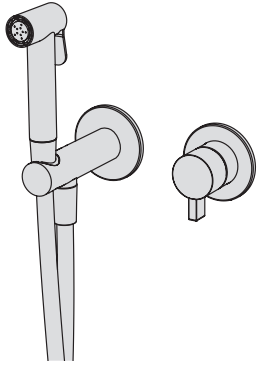

Parte estetica idroscopino a doccia per pulizia personale incasso a muro con miscelatore meccanico integrato

External part for wall-mounted multi-jet toilet hydrobrush for personal hygiene with integrated manual mixer

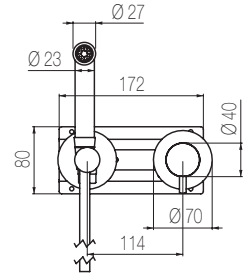
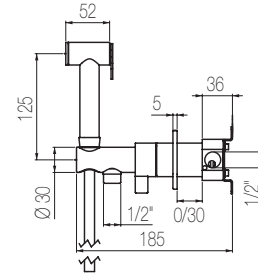

Code Finishing Price

IDQ4 S Acciaio spazz. / Brushed steel €

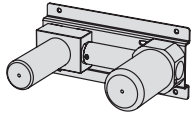

Parte incasso / Built-in part Vedi a / See at pg.271

Code Finishing Price

INN30 S Acciaio spazz. / Brushed steel €



Idroscopino per pulizia sanitari / Hydrobrush for sanitary cleaning

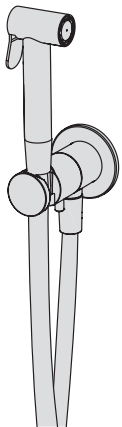

Idroscopino monogetto per pulizia sanitari con rubinetto di chiusura

Single-jet toilet hydrobrush for sanitary cleaning with stop valve

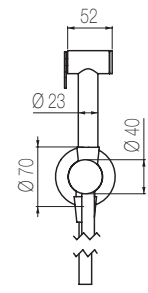
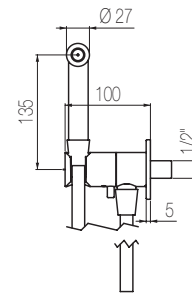

Code Finishing Price

IDR1 S Acciaio spazz. / Brushed steel €



Placca WC

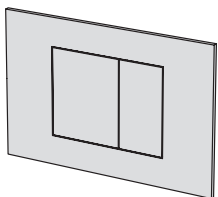

Placca per cassetta wc doppio flusso. Compatibile con Geberit mod. Sigma e con Tece
Flush plate for dual flush system. Compatible with Geberit mod. Sigma and with Tece

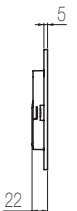
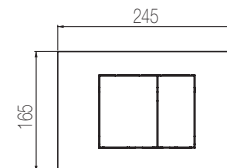

Code Finishing Price

SQUARE S Acciaio spazz. / Brushed steel €



Rubinetto d'arresto / Stop valve



Parte estetica per rubinetto di arresto incasso a muro - raccordo 1/2"

External part for wall-mounted stop valve - 1/2" connection

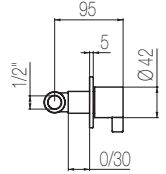
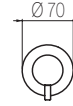

Code Finishing Price

TXQ49 S Acciaio spazz. / Brushed steel €



Parte incasso / Built-in part Vedi a / See at pg. 271

Code Finishing Price

INC49 S Acciaio spazz. / Brushed steel €



Rubinetto d'arresto / Stop valve



Parte estetica per rubinetto di arresto incasso a muro - raccordo 3/4"

External part for wall-mounted stop valve - 3/4" connection

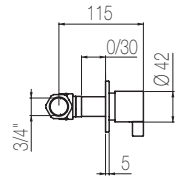
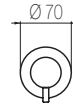

Code Finishing Price

TXQ50 S Acciaio spazz. / Brushed steel €



Parte incasso / Built-in part Vedi a / See at pg. 271

Code Finishing Price

INC50 €

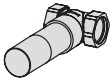

Placca WC

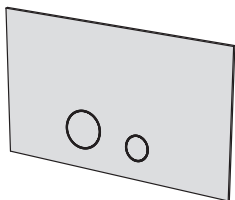

Placca per cassetta WC doppio flusso. Compatibile con Geberit mod. Sigma
Flush plate for dual flush system. Compatible with Geberit mod. Sigma

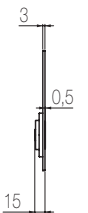
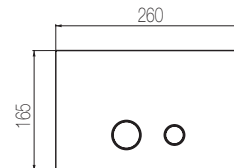

Code Finishing Price

OCHO S Acciaio spazz. / Brushed steel €





Inox spazzolato - S
Brushed stainless steel - S

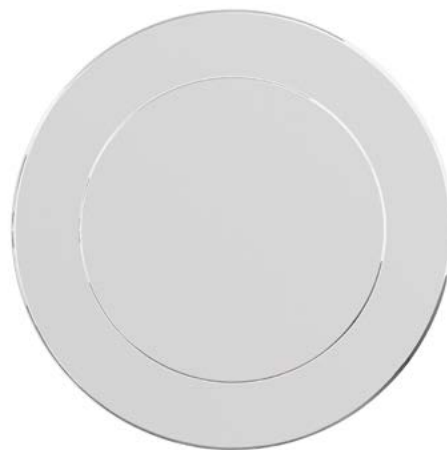

Inox lucido - L
Polished stainless steel - L



PVD Carbon spazzolato - CS
PVD brushed Carbon - CS



PVD Roseè spazzolato - RS
PVD brushed Roseè - RS















PVD Oro spazzolato - GS
PVD brushed Gold - GS























Finitura PVD Bronzo spazzolato - BS
PVD brushed Bronze finish - BS

I colori qui rappresentati sono da considerarsi solamente indicativi.
La cartella materiali con i campioni fisici in finitura può essere ordinata con il codice CAMPCOLOR al prezzo di € 60,00 netti.
The colors here indicated must be considered as an indication only.
The materials folder with the physical finishing samples can be ordered with code CAMPCOLOR at a net price of € 60.00.

Icone / Icons

 Prodotto a risparmio idrico portata 5/16 Lt/min Product with reduced flow rate 5/16 Lt/min	 Prodotto con rubinetto acqua calda e fredda separati Product with separate hot and cold tap handles	 Prodotto con 2 uscite (sistemi doccia) Product with 2 outlets (shower systems)
 Prodotto a portata standard 20/26 Lt/min Product with standard flow rate 20/26 Lt/min	 Prodotto con opzione installazione verticale o orizzontale Product that can be installed vertically or horizontally	 Prodotto con 3 uscite (sistemi doccia) Product with 3 outlets (shower systems)
 Prodotto a grande portata 30/40 Lt/min Product with high flow rate 30/40 Lt/min	 Prodotto che necessita di parti incasso Articolo incasso segue dopo prodotto Product with mandatory built-in part The necessary article follows right after the product	 Prodotto con 4 uscite (sistemi doccia) Product with 4 outlets (shower systems)
 Prodotto con comando ad azionamento sull'acqua fredda Product with cold water opening position	 Prodotto con 1 uscita Product with 1 outlet	 Prodotto con 5 uscite (sistemi doccia) Product with 5 outlets (shower systems)

Finiture / Finishes

Serie Zero / Zero series		Serie Wellness / Wellness series	
 S Inossidabile spazzolato Brushed stainless steel	 SB Inossidabile spazzolato + sabbiatura Brushed stainless steel + sandblasting	 NS Carter inossidabile spazzolato + piastra nero opaco Outer frame brushed stainless steel + matt black plate	
 L Inossidabile lucido Polished stainless steel	 LB Inossidabile lucido + sabbiatura Polished stainless steel + sandblasting	 NL Carter inossidabile lucido + piastra nero opaco Outer frame polished stainless steel + matt black plate	
 CS Finitura PVD Carbon spazzolato PVD brushed Carbon finish	 CSB Finitura PVD Carbon spazzolato + sabbiatura PVD brushed Carbon finish + sandblasting	 NCS Carter PVD Carbon spazzolato + piastra nero opaco Outer frame PVD brushed Carbon finish + matt black plate	
 RS Finitura PVD Roseè spazzolato PVD brushed Roseè finish	 RSB Finitura PVD Roseè spazzolato + sabbiatura PVD brushed Roseè finish + sandblasting	 NRS Carter PVD Roseè spazzolato + piastra nero opaco Outer frame PVD brushed Roseè finish + matt black plate	
 GS Finitura PVD Oro spazzolato PVD brushed Gold finish	 GSB Finitura PVD Oro spazzolato + sabbiatura PVD brushed Gold finish + sandblasting	 NGS Carter PVD Oro spazzolato + piastra nero opaco Outer frame PVD brushed Gold finish + matt black plate	
 BS Finitura PVD Bronzo spazzolato PVD brushed Bronze finish	 BSB Finitura PVD Bronzo spazzolato + sabbiatura PVD brushed Bronze finish + sandblasting	 NBS Carter PVD Bronzo spazzolato + piastra nero opaco Outer frame PVD brushed Bronze finish + matt black plate	
Serie Cucina Kàto / Kàto Kitchen series			
 SR Inossidabile spazzolato + leva rossa Brushed stainless steel + red lever		 SN Inossidabile spazzolato + leva nera Brushed stainless steel + black lever	

Le finiture in PVD prevedono tempi di consegna a preventivo.
For PVD finishes delivery time upon request.

Special thanks to:

Spghettiwall.it

Le carte da parati presenti
in questo catalogo fanno parte
della collezione The Book N°1 /
Spaghetti Wall.

The wallpapers used on this
catalogue are from The Book N°1 /
Spaghetti Wall collections.

Graphic designer

Stefano Baracetti - UnostudioX (Pn)
Manuel Da Rold - UnostudioX (Pn)

Copywriter

Giulia Tomba - UnostudioX (Pn)

Rendering

Tamara Pizziol - UnostudioX (Pn)
Antonia Cardin - UnostudioX (Pn)
Michele Guerra (Pn)

Photography

Riccardo Munarin - Fotografica (Pn)

Photolithography

LuceGroup (Ud)

Print

Imoco (Tv)

I colori delle finiture prodotto presenti nel catalogo sono da considerarsi solamente indicativi.
The colors of the product finishes in this catalogue must be considered as an indication only.

REV 00/04/2022

GEDA Srl

Via Maestri del Lavoro 16/18
33080 Porcia (Pn) Italy

Tel. +39 0434 923077
Fax +39 0434 591923

info@radomonte.it
radomonte.it

